

***Manual***  
***RT-202***

***Precision Direction Finder***

**RHO**

*The Leader in DF*

Elektronik GmbH

**THETA**

**Edited by:**

RHOTHETA Elektronik GmbH  
Dr.-Ingeborg-Haeckel-Str. 2  
82418 Murnau  
Germany

Tel.: +49 8841 4879 - 0  
Fax: +49 8841 4879 - 15

Internet: [www.rhotheta.de](http://www.rhotheta.de)  
E-Mail: [email@rhotheta.de](mailto:email@rhotheta.de)

*Copyright © RHOTHETA Elektronik GmbH  
All rights reserved  
Issue: [2015/05/21] [Rev 3.06]*

**HINT**



The manufacturer reserves on making modifications at any time and without previous information of the here described product.

**PLEASE NOTE:**

As a result of the advanced development of the direction finder bearing unit, it is not possible to combine devices of the new generation (serial-number higher than 1000) with devices out of older generations, e.g. antenna unit N° xx-xx-0999 does not work with display unit N°xx-xx-1001 and conversely due to the advanced technical standard!

## Index

<b>1 GENERAL INFORMATION</b>	<b>7</b>
1.1 Intended purpose of the Direction Finder	7
1.2 Delivery content of the Direction Finder	7
1.3 Front view of the Display Control Unit (DCU)	8
1.4 Rear view of the Display Control Unit (DCU)	10
<b>2 TECHNICAL DATA</b>	<b>11</b>
2.1 Electrical characteristics	11
2.2 Power supply and Remote – interface	12
2.3 Mechanical characteristics	13
<b>3 PUTTING INTO OPERATION</b>	<b>14</b>
<b>3.1 Installation of the Display Control Unit</b>	<b>14</b>
3.1.1 Mounting of the Display Control Unit	14
3.1.2 Connecting the power supply	15
3.1.3 Grounding of the Display Control Unit	15
3.1.4 Connecting the antenna cable	16
<b>3.2 Installation of the DF antenna</b>	<b>18</b>
3.2.1 Selecting the antenna position for mobile uses	18
3.2.2 Selecting the antenna position for stationary uses	18
3.2.3 Assembly of the antenna	18
3.2.4 Mounting of the antenna rods	19
3.2.5 Adjusting the antenna for mobile uses	20
3.2.6 Adjusting the antenna for stationary use	20
<b>3.3 Serial RS-232 Data Interface / Data protocol</b>	<b>21</b>
3.3.1 Interface data	21
3.3.2 Data output	21
3.3.3 Data input	23
3.3.4 Connector holding	23
3.3.5 Connecting cable Direction Finder ↔ PC	24
<b>3.4 Installation of supplement devices</b>	<b>24</b>
3.4.1 External speaker	24
3.4.2 Alarm bell	24
3.4.3 External ON/OFF switch	24

<b>4 OPERATION</b>	<b>25</b>
<b>4.1 Display functions</b>	<b>25</b>
4.1.1 Switch-on reaction	25
4.1.2 Bearing display - circle of LED's	25
4.1.3 Display > Level <	25
4.1.4 Display > Signal <	26
4.1.5 Display >  <	26
4.1.6 Display > Test-Freq. <	26
4.1.7 Display > Speaker Off <	26
4.1.8 Display > ELT only <	26
4.1.9 Signal device	26
<b>4.2 Operating functions</b>	<b>27</b>
4.2.1 Switching ON/OFF of the Direction Finder	27
4.2.2 Function > CLEAR < as clearing function for the average memory	27
4.2.3 Function > CLEAR < as analysis of bearing quality	27
4.2.4 Function > REPEAT <	27
4.2.5 Function > VOLTAGE < displays the actual battery voltage or power supply	28
4.2.6 Function >  < (Speaker) switch off / on speaker	28
4.2.7 Function > IDENT < (Distress-Signal identification)	28
4.2.8 Function > FREQ. <	29
4.2.9 Function > SQUELCH - <	29
4.2.10 Function > SQUELCH + <	29
<b>4.3 Additional functions</b>	<b>30</b>
4.3.1 Adjusting of a display-offset	30
<b>4.4 Testing of nominal qualities</b>	<b>30</b>
4.4.1 Testing of nominal qualities on watercrafts or land vehicles	31
4.4.2 Testing of nominal qualities, stationary use.	32
<b>5 AVAILABLE ACCESSORIES</b>	<b>32</b>
<b>6 DECLARATION OF CONFORMITY</b>	<b>33</b>
<b>7 APPENDIX</b>	<b>34</b>
7.1 Test protocol	34
7.2 Drawing for mounting of the Display Control Unit	34

## List of Figures

<i>Front view of the Display Control Unit (DCU) in standard POM-version</i>	8
<i>Rear view of the operating / display unit</i>	10
<i>Power / Remote - interface</i>	12
<i>Direction finder antenna</i>	13
<i>Connection of antenna cable</i>	16
<i>Assembly of the antenna rods</i>	19
<i>Example: time diagram of data output with existing receiving signal</i>	21
<i>List of all possible serial messages</i>	22
<i>Pin holding serial connector on Direction Finder</i>	23
<i>Serial connection cable for Direction Finder</i>	24
<i>Display of actual battery voltage or power supply</i>	28
<i>Approach to the transmitter despite 30° bearing error</i>	31
<i>Stencil drawing for mounting of the display unit</i>	35

Thank you very much for buying a direction finder of the company RHOTHETA Elektronik GmbH. We would like to ask you now to read this operating manual completely and carefully in order to avoid possible damages caused by incorrect operation or assembly.

# 1 General information

## 1.1 Intended purpose of the Direction Finder

The direction finding system RT-202 is designed for detecting and locating emergency signals, transmitted by a beacon on the international emergency frequency 121.500 MHz. So the unit can be used as a homing DF-system to a beacon and support so rescue activities.

The direction finder satisfies all requirements put to a professional direction finding system during hard operation on vessels, land vehicles or when used as a portable device.

The direction finder RT-202 is **not** designed for navigation requirements.

## 1.2 Delivery content of the Direction Finder

The delivery content of the Direction Finder consists of following parts:

- 1 Manual
- 1 Display unit (standard version: POM-housing)
- 1 Antenna (standard version: screw-flange)
- 1 Mast bolted joint (standard version)
- 1 Reducer 50 to 40 mm (standard version)
- 8 Antenna rods
- 1 Antenna cable 10 m with connectors
- 1 Spare fuse (0,8A inert)
- 4 Assembly bolts M4 stainless
- 4 Washers M4 stainless
- 4 Assembly nuts M4 stainless
- 1 Power / Remote cable with fuse holder
- 1 Test protocol
- 1 Stencil drawing for mounting display unit

## 1.3 Front view of the Display Control Unit (DCU)

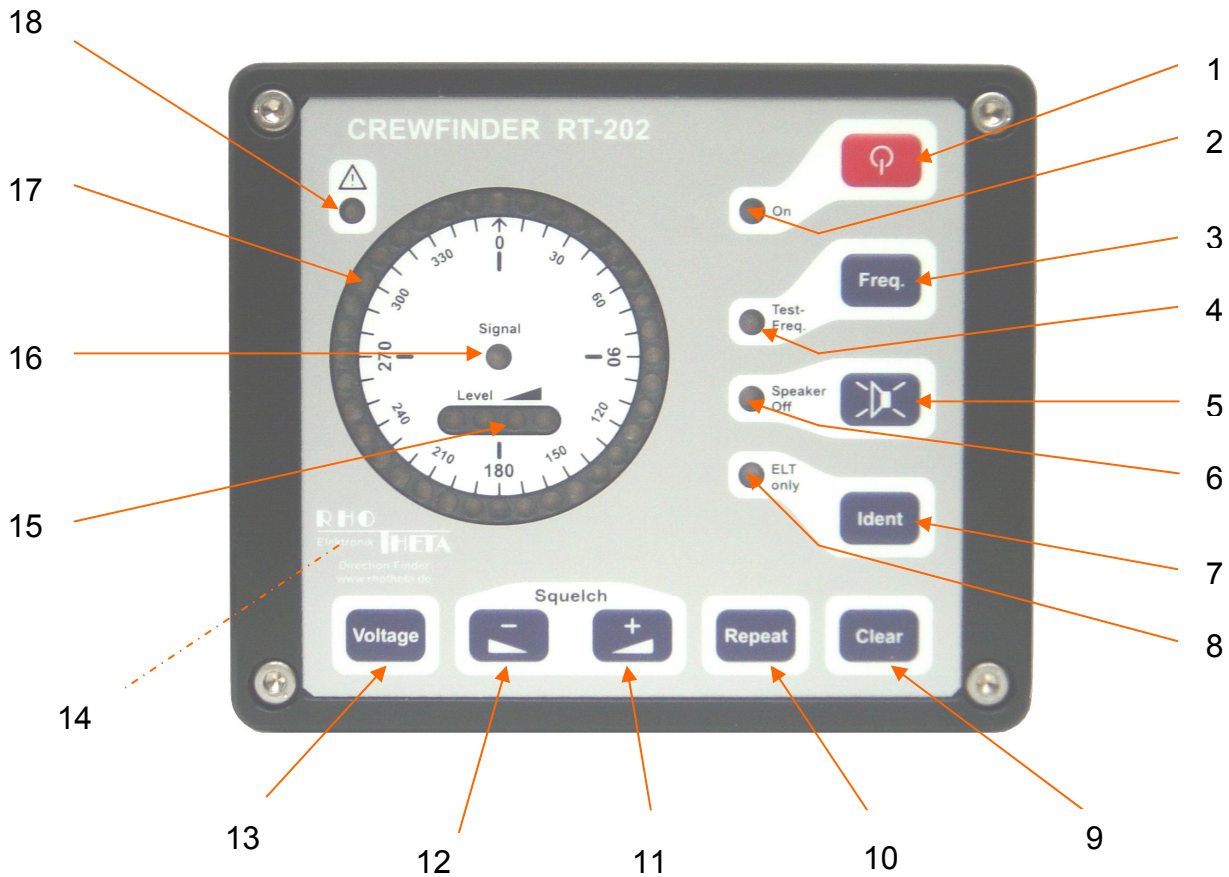

Front view of the Display Control Unit (DCU) in standard POM-version

### Operating elements of the Direction Finder RT-202

(Look for more detailed description in the chapters)

- (1) On/Off - switch of the direction finder.
- (2) Green Power-On-LED flashes when ready for operation (every second).
- (3) Selection between the two receiver-channels / frequencies.  
frequency I = international distress-frequency: 121.500 MHz  
frequency II = test-frequency: 121.650 MHz
- (4) Red indication-LED for selected test-frequency (frequency II).
- (5) On/Off - switch for internal SPEAKER and - if connected to remote interface - external speaker and alarm-output.
- (6) Red warning-LED for switched off speaker and alarm exit.



- (7) On/Off - switch for distress-signal-Identification.
- (8) Red indication-LED for activated Distress-Signal-Identify.
- (9) CLEAR-push-button for clearing the averaged direction value memory and display of the not averaged direction value for signal quality analysis.
- (10) REPEAT-push-button for last given direction value.
- (11) SQUELCH +: Pressing this button will show the current squelch level on circular display. Pressing the button for more than 2 seconds will increase and simultaneously show the squelch level.
- (12) SQUELCH -: Pressing this button will show squelch level on circular display. Pressing the button for more than 2 seconds will decrease and simultaneously show the squelch level.
- (13) VOLTAGE-push-button for indication of the present supply voltage.
- (14) internal speaker ► (under the foil)
- (15) Display of the LEVEL of the incoming signal by four green LED's.
- (16) SIGNAL squelch indicator, red LED lit when signal is received.
- (17) Direction finding indication by 36 red LED's.
- (18) Red warning-LED for intolerable frequency deviation of the received signal ( $> \pm 5.5$  kHz).

## 1.4 Rear view of the Display Control Unit (DCU)

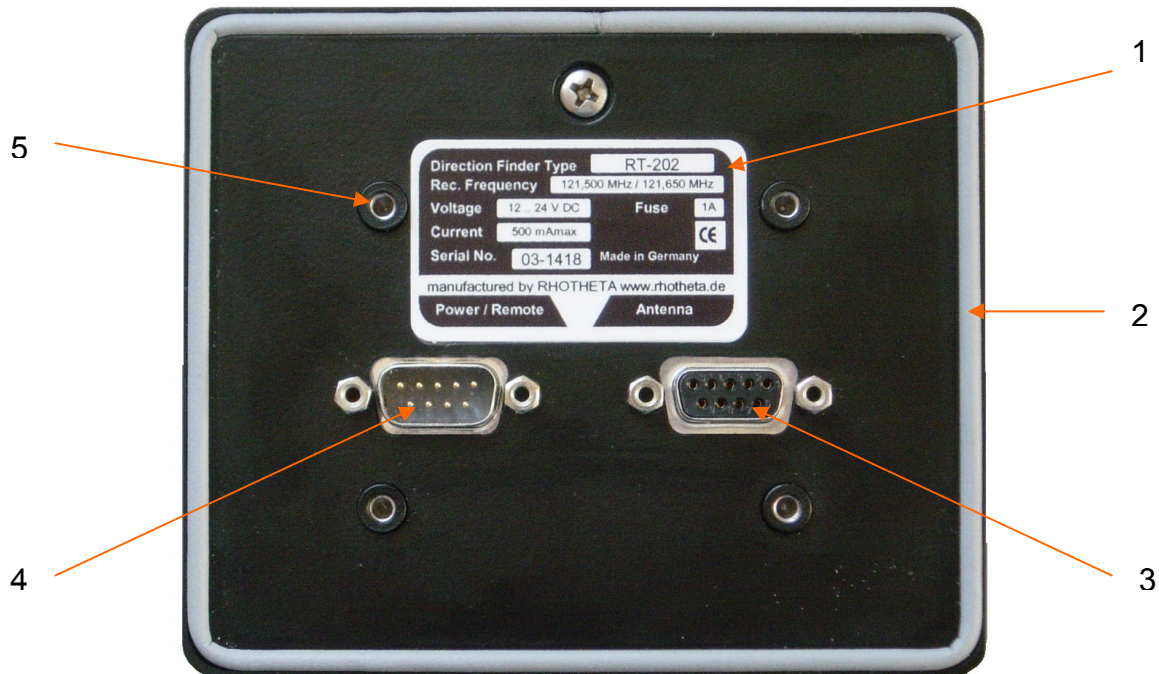

Rear view of the operating / display unit

- (1) Type label (do NOT remove, warranty depends on it)
- (2) Rubber sealing
- (3) D-Sub socket "Antenna" for connecting the antenna cable
- (4) D-Sub socket "Power / Remote" for
  - power supply
  - optional connection of a PC (serial RS-232)
  - an external speaker
  - activation of alarm
  - an external ON/OFF- switch
- (5) Screw socket for fixing the display unit (4x M4) and connection for ground

## 2 Technical Data

### 2.1 Electrical characteristics

- Method of bearing      Doppler-principle (3 kHz frequency of rotation, cw / ccw)
- Bearing reverence      relative bearing (reverence is antenna orientation)
- Accuracy <sup>1</sup>:               $\pm 5^\circ$
- Internal resolution:       $2^\circ$
- Sensitivity:               $< 2 \mu\text{V/m}$ ;
- Receiving frequencies:      121.500 MHz & Test-frequency 121.650 MHz
- Bearable kinds of modulation:      A3E, F3E, A2X (Distress-Signal-modulation); DF is largely independent on kind of modulation
- Polarisation:              vertical
- Polarisation error:       $\leq 5^\circ$  at  $60^\circ$  vectorial field rotation
- Garbling cone:              ca.  $30^\circ$  measured to the vertical
- Attack time <sup>2</sup>:               $\leq 50 \text{ ms}$  (at sufficient signal strength)  
depends on the signal level and modulation.
- Distress-Signal-Identification specification      Down/Up-ward audio sweep, frequency range = [300 Hz .. 1600 Hz], repetition rate = [250 ms .. 500 ms],  $\Delta f/100 \text{ ms} = [-140 \text{ Hz} .. -520 \text{ Hz}]$
- Operating voltage:      12 .. 24 V DC, ( $\pm 10\%$ )
- current capacity:              max. 350 mA (without external speaker)  
max. 600 mA (with external speaker)
- Monitoring:              with inbuilt miniature speaker; modulation: A3E

<sup>1</sup> In undisturbed wave field and sufficient field strength. The bearing value results by changing the direction of incidence, in course of which the antenna is turned on a rotating device to exclude environmental influences on the DF value.

<sup>2</sup> Receiving very low signal levels can increase attack time considerably!

## 2.2 Power supply and Remote – interface

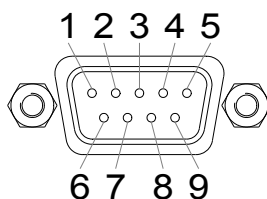

Power / Remote - interface

Pin 1	POWER supply +	12 .. 24 V DC, ( $\pm 10\%$ )
Pin 2	serial RS232 (V24) IN	1200 Baud; parity = odd; 7 data bit, 1 stop bit.
Pin 3	serial RS232 (V24) OUT	
Pin 4	external ON/OFF-switch input	at $U_{in} > 2...24 \text{ V max}$ → device is switched on ( $I_{in \text{ max.}}: < 1 \text{ mA}$ )
Pin 5	GND	ground housing
Pin 6	POWER supply GND	ground battery / power supply
Pin 7	GND	ground housing
Pin 8	Audio exit <sup>3</sup>	for external speaker (on GND) ca. 5 Vpp on 8 $\Omega$ , output power app. 0.5 Watt
Pin 9	Alarm exit	Open collector output to GND with receiving signal / alarm: $U_{out} < 1 \text{ V DC}$ ( $I_{max.}: \approx 100 \text{ mA}$ )

<sup>3</sup> The audio signal is superimposed upon the antenna scanning signal. This can affect considerably the unintelligibility of voice signals. ELT-signals will not be affected remarkably.

## 2.3 Mechanical characteristics

### Temperature range:

- tolerable operating temperature range: - 20°C .. + 60°C
- tolerable storage temperature: - 50°C .. + 70°C

### Weights:

- Display unit: app. 500 g (standard POM-version)
- DF antenna: app. 1400 g

### Dimensions:

- Display unit: length x width x height:  
120 mm x 100 mm x 45 mm
- DF antenna: D = 50 mm; without adapter  
D = 40 mm; with included adapter  
D = 32 mm; with special adapter  
D = 25 mm; with special adapter

### Protective systems:

- Display unit: IP 67
- DF antenna: IP 67<sup>4</sup>

### Lateral thrust due to wind:

- app. 14 N at 150 km/h wind speed
- app. 20 N at 180 km/h wind speed

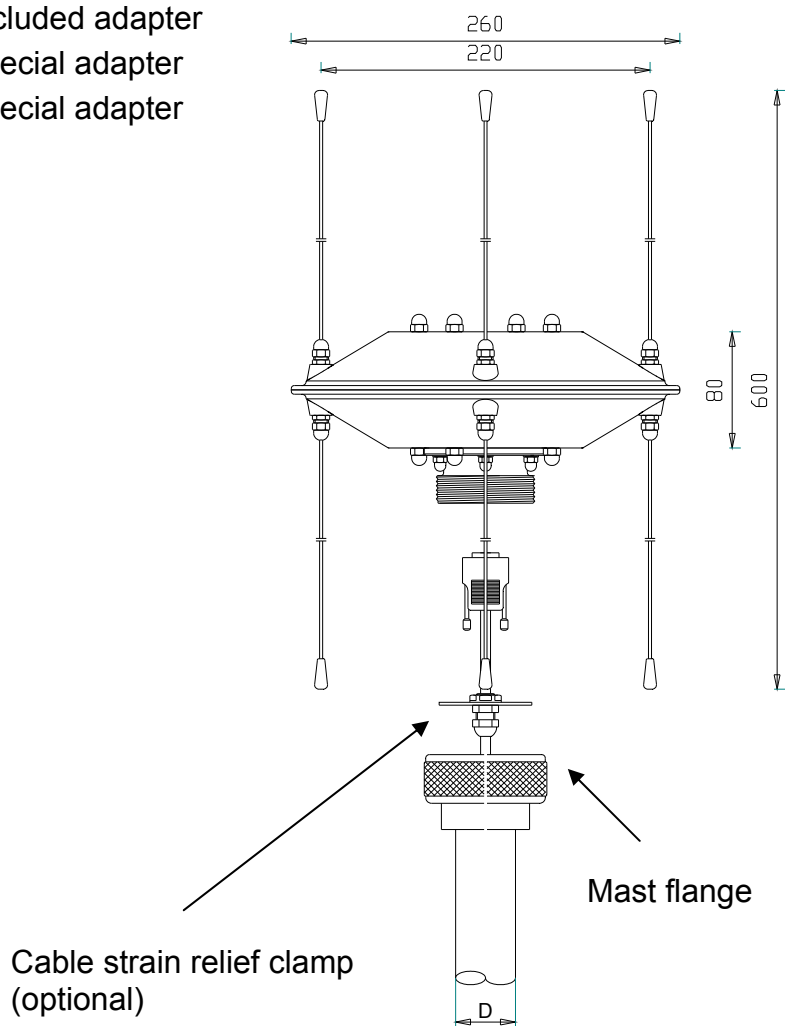

*Direction finder antenna*

<sup>4</sup> It is recommended to seal the mast tube, to protect the connectors from moisture. For this purpose the additional available mast sealing can be used.

## 3 Putting into Operation

### 3.1 Installation of the Display Control Unit

#### 3.1.1 Mounting of the Display Control Unit

##### Mounting surface

The Display Control Unit (DCU) should be mounted on a plane, smooth and stable surface. The backside of this surface has to be accessible, so that the mounting elements, antenna- and power/remote connectors are within reach. Additionally the backside has to be protected durable from moisture.

On watercrafts the display unit should be mounted near the steering controls, thus obtaining good readability under all circumstances.

##### Mounting

- Make sure that there are no other endangered elements within the mounting surface (e.g. power lines, gas or water pipes)
- Cut out the added mounting template and transfer the four mounting drill holes and the hole for the connectors onto the surface.
- Drill the holes (7.5 mm diameter) for the bolts.
- Cut out the hole for the connectors.
- Screw the M4 bolts with a screwdriver into the screw socket of the display unit. Don't fix the bolts too strong. Additionally the bolts should be secured with LOCTITE® screw locking in case of sensible vibrations (e.g. Diesel engine).
- In case of difficult access to the backside of the mounting surface all connectors should be fixed now.
- Add a thin and homogenous layer of sealing compound to the sealing surface of the display unit.
- Plug the bolts of the display unit into the assigned drill holes so that the surfaces have full contact.
- Now the display unit should be pressed in correct position onto the mounting surface whilst mounting the washers and nuts from the inside. Tighten the nuts, use LOCTITE®-screw locking if necessary.

### 3.1.2 Connecting the power supply

For putting into operation a 12V (..24 V) DC power supply is needed.

The power supply is fused with a 0,8A fuse, independently from other current consumers.

The power supply requires a cable with a minimum cross sectional area of 0.75 mm<sup>2</sup>.

Use the by packed connector with the already assembled cable. Here the red cable has to be connected with + 12 .. 24V and the black one to ground (GND).

**WARNING:**

The power supply ground is connected via a noise suppression choke to the DCU case ground. So there is no galvanic separation between this both potentials.

If power supply ground and ship ground are not on the same potential, strong equalising current can destroy the unit. Therefore it is strictly recommended to use a galvanic isolated DC/DC converter!

**WARNING:**

NEVER activate the unit without fuse.

Wrong connection of power supply will destroy the display unit!

### 3.1.3 Grounding of the Display Control Unit

The Display Control Unit has to be grounded to the ground of the ship or land vehicle where it is mounted. This connection should be realised via one of the 4 screw sockets at the back side of the display case.

### 3.1.4 Connecting the antenna cable

Plug the delivered antenna cable into the socket >Antenna< and tighten both screws of the connector.

In case of manufacturing your own antenna cable, following connecting scheme has to be applied:



Connection of antenna cable

**Type of connector:** 9-pole D-Sub-female connector      9-pole D-Sub male connector  
**Type of cable:** 9-pole + shielding  
 cross sectional area min. AWG 24 (0.23 mm<sup>2</sup>)

#### Connection table for normal antenna mounting:

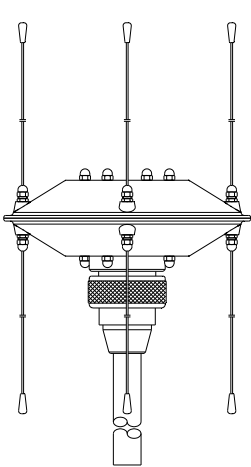

<i>Display unit</i>		<i>Antenna unit</i>	<i>Signal</i>
contact 1	↔	contact 1	control current EAST
contact 2	↔	contact 2	control current WEST
contact 3	↔	contact 3	channel select
contact 4	↔	contact 4	level
contact 5 (power supply)	↔	contact 5	supply voltage 12 ..24 V
contact 6	↔	contact 6	control current SOUTH
contact 7	↔	contact 7	control current NORTH
contact 8	↔	contact 8	Audio
contact 9	↔	contact 9	DF-signal
connector shield (GND)	↔	connector shield (GND)	Ground

**Remarks:**

maximum length of cable: app. 50 m.  
 Cable shield to be connected with connector shield!  
 If using a 10-wired cable it is recommended to put the power supply onto 2 conductors (pin 5).

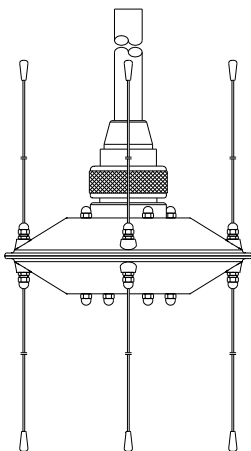

**Connection table for upside down antenna mounting:**

<i>Display unit</i>		<i>Antenna unit</i>	<i>Signal</i>
contact 1	↔	contact 2	control current EAST
contact 2	↔	contact 1	control current WEST
contact 3	↔	contact 3	channel select
contact 4	↔	contact 4	level
contact 5 (power supply)	↔	contact 5	supply voltage 12 ..24 V
contact 6	↔	contact 6	control current SOUTH
contact 7	↔	contact 7	control current NORTH
contact 8	↔	contact 8	Audio
contact 9	↔	contact 9	DF-signal
connector shield (GND)	↔	connector shield (GND)	Ground

**WARNING:**

If the antenna is mounted in the upside down way, then pay attention that the mast tube is sealed up. No water should come to the D-Sub connector.

The D-Sub connector is not waterproof! If water comes into the antenna, the antenna will be destroyed!

The standard antenna cable is only useable for normal mounting and must not be used for upside down mounting!

## 3.2 Installation of the DF antenna

### 3.2.1 Selecting the antenna position for mobile uses

A suitable position of the antenna is of utmost importance for the undisturbed function of the direction finder. VHF-radio signals (or UHF-radio signals) of a transmitter (e.g. Distress-Signal) are propagating in a >quasi optic< manner. Therefore, transmitter and antenna should be within a >theoretic< range of vision. That means, the higher the mounting of the antenna the better the radio connection (range) and the better the DF signal.

Obstacles as mast, rigging and radar antenna between antenna and transmitter might turn out as extremely disturbing.

So the mast is considered to be the best mounting position on watercrafts.

On yachts a mounting position on the stern is often favoured. A suitable mounting position has to be found out in this case by >try and error< (see Testing of nominal qualities, chapter 4.4). In any case the antenna has to be mounted in a sufficient high position (> 2m), thus avoiding bad DF-signals caused by crew members.

On land vehicles the DF antenna should be mounted in a central position, app. 50 cm above the roof.

### 3.2.2 Selecting the antenna position for stationary uses

Here also the suitable position of the antenna is of utmost importance for the undisturbed function of the direction finder. The mounting position should be as obstacle free as possible (trees, buildings, walls...) to avoid disturbing reflections. Even other antennae or e.g. wind measuring devices are not allowed to be on the same level.

In case of bearing airborne signals, the DF antenna should be fixed to a mast (50 mm in diameter) and four meters in height (4 m should not be exceeded). A higher mast might cause wrong DF values because of ground reflections, minor heights can easily produce wrong DF values because of reflections on vehicles, bushes, tents or similar obstacles.

### 3.2.3 Assembly of the antenna

The antenna is to be mounted on a suitable mast tube (external diameter 50 mm or 40 mm if using included reducer). Preferably, the mast tube should consist of synthetic material. The internal diameter should be at least 36 mm, in case of using smaller mast tubes the connector of the antenna cable has to be adapted.

Put the nut (thread to the top) onto the mast tube. Then glue mast tube and tube flange<sup>5</sup> by using suitable glue - for the 40 mm external mast diameter use the included reducer. Reducers for other diameters can be delivered on request.

Pull the antenna cable through the mast tube. The female multipoint connector has to be on the side of the antenna. If using free lengths of cable exceeding 10 m an additional pull relief has to be provided.

Connect the antenna cable to the antenna head and tighten the bolting of the connector. In case of using an own cable the cable links have to be executed following instructions of chapter 3.1.4 >Connecting the antenna cable<.

Put the antenna onto the mast flange. Take care that the o-ring of the antenna head fits properly to it's groove. Fix the nut slightly.

---

<sup>5</sup>The tube flange is made of PVC, suitable glue e.g.: Tangit of firm „Walter Sahlberg GmbH &Co“  
*Manual RT-202*

When mounting the antenna on yachts take care that the bottom end of the mast is sealed, for in case of capsizing the erection of the yacht may become more difficult because of the penetrated water.

### 3.2.4 Mounting of the antenna rods

Plug the rods of the antenna into the rod sockets of the antenna head until the fitting lies completely in the groove of the drilling (see drawing).

Tighten fully the nut by hand until sensible resistance. Then tighten the nuts carefully by using a 10 mm box end wrench. Do not exceed a torque of 3 Nm.

Do not bend antenna rods, it might cause bearing errors.

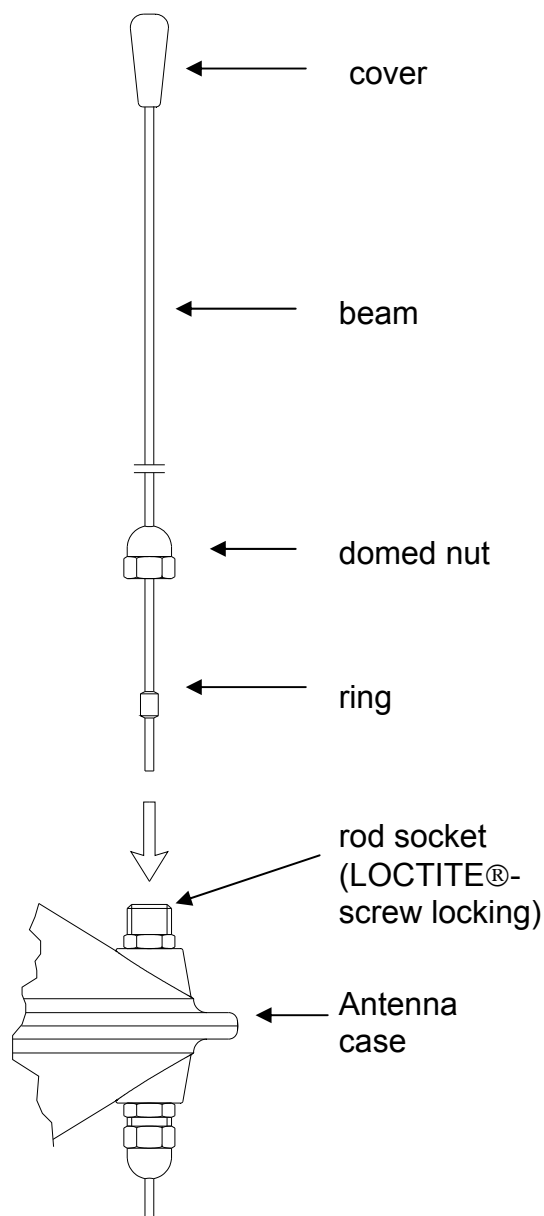

*Assembly of the antenna rods*

### 3.2.5 Adjusting the antenna for mobile uses

Before putting into operation the direction finder the DF antenna has to be adjusted exactly. On watercrafts and land vehicles the reference direction is the longitudinal axis. The DF antenna ought to be adjusted in a way that the arrow marked pair of rods leads parallel to bow respectively to vehicle front.

The proper adjustment is to be checked under assistance of a transmitter as described in chapter >Testing of nominal qualities<.

Antenna axis (North) and longitudinal axis of the watercraft might not correspond if antenna mounting has to be in an inevitably unfavourable position because of reflections. Further hints about adjusting and testing the DF system are found in chapter 4.4 >Testing of nominal qualities<.

### 3.2.6 Adjusting the antenna for stationary use

When installed for stationary use (bearing of aircrafts) the reference direction is either magnetic North (QDM, QDR) or geographic North (QUJ, QTE).

- Adjusting the reference direction QDR:
  - a) The DF antenna has to be positioned in a at least 100 m distance to the transmitter.
  - b) Find out the direction (magnetic) from the transmitter to the DF antenna by using a compass.
  - c) Add (respectively subtract) 180° to (from) the indicated compass reading. The result is the nominal value to be indicated.
  - d) Switch on the transmitter and put it into air continuously.
  - e) The DF antenna is to be adjusted (rotated) so, that the display unit shows the before (above) found out value.
  - f) Fix the antenna by tightening the bolts.

In order to check the adjustment, try different antenna positions. If differences should arise another antenna position has to be found.

#### **WARNING:**

Touching the antenna when rotating the bearing will falsify considerably. Therefore, before reading the values take care that nobody stays near the antenna.

- Adjusting of reference direction QDM:  
Is to be done like „adjusting the reference direction QDR“ except adding or subtracting 180°. The nominal value has to correspond to the found out compass reading.
- Adjusting of reference direction QUJ:  
Is to be done like „adjusting the reference direction QDM“. The value of the local magnetic declination has to be subtracted from the nominal value.
- Adjusting of reference direction QTE:  
Is to be done like „adjusting the reference direction QDR“. The value of the local magnetic declination has to be subtracted from the nominal value.

## 3.3 Serial RS-232 Data Interface / Data protocol

### 3.3.1 Interface data

Data transfer rate = 1200 Baud, parity = odd, 7 data bits, 1 stop bit  
no transfer protocol (3-wire link)

### 3.3.2 Data output

#### General information

All information and DF values of importance are put out continuously (without demand) by the DF device by a serial RS-232 interface coded in ASCII data strings. Each data string (block of several bytes) owns a certain ASCII -sign used as initial identifiable signal and two ASCII -signs used as end mark. In between the information is coded as ASCII decimals.

A status message will be put out three times per second, giving information if a DF signal was received or not. When receiving a signal and after putting out the status message the receiving level will be indicated (in %) as well as the averaged DF value (in °). Additionally the un-averaged momentary DF value is put out.

#### Data output protocol

- Each message starts with a header-sign (ASCII-sign for identifying the type of message). Following headers are possible: "S" = hex53, "P" = hex50, "V" = hex56, "A" = hex41, "L" = hex4C, "N" = 0x4E.
- Then follows the proper information, consisting of three ASCII decimals: "0" to "9" = hex30 to hex39
- As end mark two ASCII final marks are used: "CR" = hex0D (Carriage Return) and "LF" = hex0A (LineFeed)

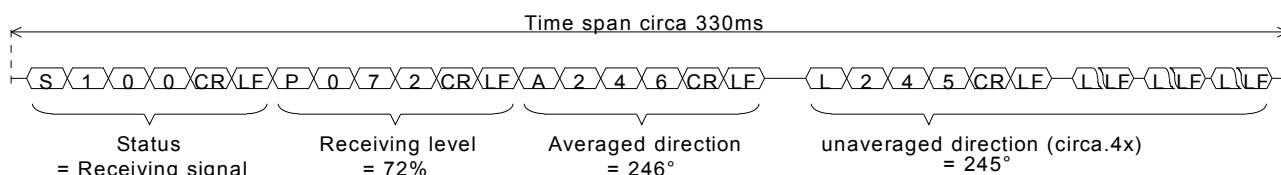

*Example: time diagram of data output with existing receiving signal*

Header	content	specification
S	xxx = 0xx = 2xx  = 1xx	Status output: - no received signal (no bearing) - received signal but active frequency storage (no bearing / error caused by exceeding frequency deviation of transmitted signal ( $> \pm 6\text{kHz}$ ) - receiving signal (bearing active)
P	xxx = 000 .. 099	level of received signal / field intensity in %
V	xxx = 050 .. 280	display of supplied voltage e.g. 132 corresponds to 13.2Volt
N	xxx = 000 .. 255	Low audio-frequency (averaged about 100ms) in 10Hz e.g. 124 corresponds to 1240Hz
A	xxx = 000 .. 358	averaged DF value in degrees (average-value, resolution 2 degrees)
L	xxx = 000 .. 359	Not averaged DF value in degrees (momentary value, resolution 1 degree)

*List of all possible serial messages*

## Remarks

- The un-averaged DF value shows a certain spread, depending on the received signal. It can be used, if required, as indicator of the DF value quality. When working with the Direction Finder only the displayed averaged value should be used.
- After switching on the direction finder, several information concerning the serial interface are put out. They give information about version of software, serial number of the device and all the settings of the EEPROM.
- All serial data can be read under assistance of a PC and terminal programme (e.g. Terminal in Windows or Norton). Each message is displayed in a new line.

### 3.3.3 Data input

Each message send to the Direction Finder consists of the ASCII coded data string and the end mark of two ASCII chars "CR" = hex0D (Carriage Return) and "LF" = hex0A (LineFeed).

Message (ASCII data string)	specification
SQUELCH[xx]	Squelch-Level in the range xx = 00 .. 70 (Default Value=36) 00 = very sensitive, but also receiving noise 70 = less sensitive, only very strong signals are received (see 4.2.9 and 4.2.10 Operating Functions / Function >SQUELCH±<)
FREQUENCY_NORM FREQUENCY_TEST	Switching active frequency to: 121.500 MHz (DISTRESS-SIGNAL) 121.650 MHz (for Test) (see 4.2.8 Operating Functions / Function >FREQ.<)
VOLUME_ON VOLUME_OFF	Volume/speaker is switched On/Off (see 4.2.6 Operating Functions / Function >▶<)
ELTIDENT_ON ELTIDENT_OFF	Automatic Distress-Signal-Identification is switched On/Off (see 4.2.7 Operating Functions / Function >IDENT<)

### 3.3.4 Connector holding



*Pin holding serial connector on Direction Finder*

### 3.3.5 Connecting cable Direction Finder ↔ PC

Do not use serial connecting cables, because several pins of the direction finder Power/Remote connector are used for other, additional functions (danger of shortcut).

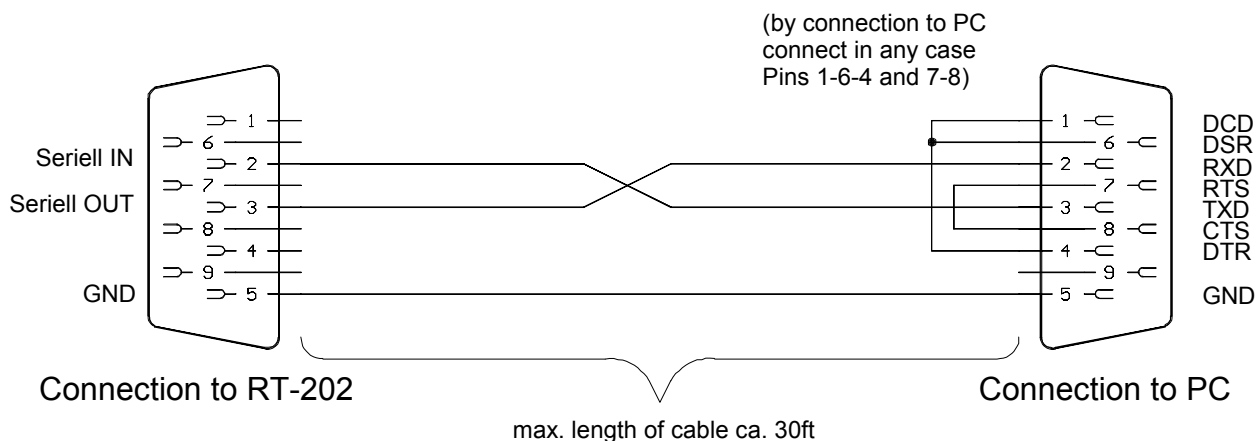

Serial connection cable for Direction Finder

## 3.4 Installation of supplement devices

See also chapter 2.2 >Power supply and Remote – interface<.

### 3.4.1 External speaker

The external speaker reproduces the LF-audio-signal of the transmitter. It is superimposed upon the antenna scanning sound (3 kHz); the signal quality of Distress-Signal transmitters is not influenced audibly. The external speaker can be switched off, (see Function > ▶ < (Speaker) switch off / on speaker, chapter 4.2.6).

### 3.4.2 Alarm bell

This open-collector output is switched to >Low< (< 1 Volt) when activated. This allows the connection of an alarm bell, when using a relay (control current max. 100 mA). This alarm output is low active until the emergency transmitter is switched off or the >▶<-push-button at the control device is pressed (see Function > ▶ < (Speaker) switch off / on speaker, chapter 4.2.6). The alarm bell function can also activate the „man over board“ function of a GPS-system (storage of the momentary position).

### 3.4.3 External ON/OFF switch

The external ON/OFF switch enables the continuous operation of the Direction Finder, also after a short unnoticed lack of power supply. As long as there is an input voltage 2..24V at the input of the switch the Direction Finder is in operation. The ON/OFF push-button is now disabled. In order to switch off, the external voltage has to be interrupted (respectively switched off).



## 4 Operation

The operation of the direction finder was designed to be as simple as possible. All functions for the normal use can be executed within one operation layer. In order to guarantee your crews safety, the correct function of the Direction Finder scarcely can be affected by mistake.

### 4.1 Display functions

The display of the operational status and of the DF value is realised on a great antiglare display field with extreme bright LED's. Opposite to LC displays there is still very good visibility under unfavourable circumstances (darkness, fog, direct sun).

#### 4.1.1 Switch-on reaction

After put into operation the Direction Finder executes automatically a short self-diagnosis. Then, one after the other, all 36 LED's of the reference direction display will light clockwise. At the same time the four LED's of the level display will flash (running light). All other indication-LED's are lit too.

After that, for control purposes, the adjusted offset value (corrected north, default value =0°) is displayed flashing (shortly, for one second) at the circle of LED's. Four LED's light weakly in the axis system (0°, +90°, 180°, -90°). The offset value will be shown with a precision of 5° (e.g. if the adjusted offset value is +25° , the LED's 20° and 30° are flashing at the same time). See also chapter 4.3.1 >Adjusting of a display-offset<.

After ending the self- diagnosis, the green Power-On LED is activated, thus indicating ready to operate.

#### 4.1.2 Bearing display - circle of LED's

The direction of the incoming signal is shown by 36 LED's with a precision of 10° (in the whole azimuthally range of 360°). The display always refers to the adjustment of the antenna (relative bearing).

E.g. the lit +70°-LED indicates an emergency transmitter 70° to starboard. That is the change of heading to be done to get to the victim. Once the watercraft is turning to the direction of the bearing, the display changes to direction 0° until the watercraft is heading exactly to the transmitter.

#### 4.1.3 Display > Level <

Four green LED's indicate the field strength of the incoming signal. The more LED's are lit the better the reception of the emergency signal. Rough sea can cause short changes of strength of the signal level.

#### 4.1.4 Display > Signal <

As soon as receiving a signal the display >Signal< is lit. The display >Signal< is still lit, if there is no more suitable bearable signal (frequency deviation too great, very noisy, too weak field strength).

#### 4.1.5 Display > <

This sign indicates a malfunction of the transmitter, if the frequency deviation amounts to more than 5 kHz. This might cause a bearing error of 180° under certain circumstances and lead the rescue team into the wrong direction. That is why the reference direction display of the direction finder is switched off automatically.

#### 4.1.6 Display > Test-Freq. <

This red LED indicates the activated test-frequency II (see chapter 4.2.8)

#### **WARNING:**

The test-frequency is only for use with a transmitter sending at the test-frequency. In this mode NO Distress-Signal-Transmitters (frequency 121.500 MHz) can be received!

#### 4.1.7 Display > Speaker Off <

This sign lit indicates a switched off speaker (internal, external) as well as a switched off alarm exit.

(See chapter 4.2.6 Function >  < (Speaker) switch off / on speaker)

#### 4.1.8 Display > ELT only <

This sign lit indicates a switched on Distress-Signal-Identification. With this, interfering transmitters at the receiving frequency are prevented, and only Distress-signals are activating the speaker and a connected alarm bell. The LED is flashing by receiving a Distress-Signal with a switched on Distress-Signal-Identification.

(See chapter 4.2.7 Function > IDENT <)

#### 4.1.9 Signal device

The integrated miniature speaker reproduces the received LF signal. The signal is superimposed by the 3 kHz scanning sound and therefore not more suitable for speech recognition. A distress signal (distinct howling with periodically changing sound) will not be influenced remarkably. The signal device can be switched off.

(See chapter 4.2.6 Function >  < (Speaker) switch off / on speaker)

## 4.2 Operating functions

The operation of the direction finder is done by four waterproof short stroke pushbuttons with distinct pressure point.

### 4.2.1 Switching ON/OFF of the Direction Finder

The direction finder will be activated by a short push (min. 0.5sec) on the ON/OFF-push-button. After ending the switch-on procedure (see chapter 4.1.1 >Switch-on reaction<) the green >Power On< LED appears signalling readiness for operation. The DF device is switched off by another short push on the ON/OFF-push-button.

If switched on by using the external ON/OFF switch, there is no reaction when pressing the ON/OFF-push-button.

### 4.2.2 Function > CLEAR < as clearing function for the average memory

This is a very important function. To know how to handle it, allows using the whole performance of the DF-system.

Actuating the key >CLEAR<: the averaging memory will be cancelled. After releasing the key, the averaging process is starting again. This function is to be applied in order to minimize the drag-error if receiving very weak signals.

Press >CLEAR< button:

- after changing heading to get within seconds an exact bearing display (to avoid drag error)
- from time to time if you work with weak signals to be sure that you have not lost the signal
- If the beacon is very near to see the exact moment when you pass the beacon

### 4.2.3 Function > CLEAR < as analysis of bearing quality

During pressing the >CLEAR< push-button the momentary un-averaged bearing value is displayed.

### 4.2.4 Function > REPEAT <

By pressing the push-button >REPEAT< the display shows blinking the last found out bearing value. The bearing value refers to the heading direction at the moment of the last received signal. Take care when using the repeat function after changing heading.

**4.2.5 Function > VOLTAGE < displays the actual battery voltage or power supply**

By pressing the push-button >VOLTAGE< the momentary voltage value of the power supply is displayed on the circle of LED's. The display is enlarged in the two ranges between 11.0 Volt to 13.0 Volt or 22.0 Volt to 26.0 Volt. So 0° indicates 11 Volt or 22 Volt, increases clockwise to 360° = 13 Volt or 26 Volt (complete circle).

**Remark:**

If using a 12 Volt lead storage battery, the voltage drops continuously (DF switched on) from about 13 Volt (full battery) to 11 Volt (empty battery). If the display is indicating as example 11.5 Volt (=90°) 25% of the battery's capacity (battery uninjured) are still left.

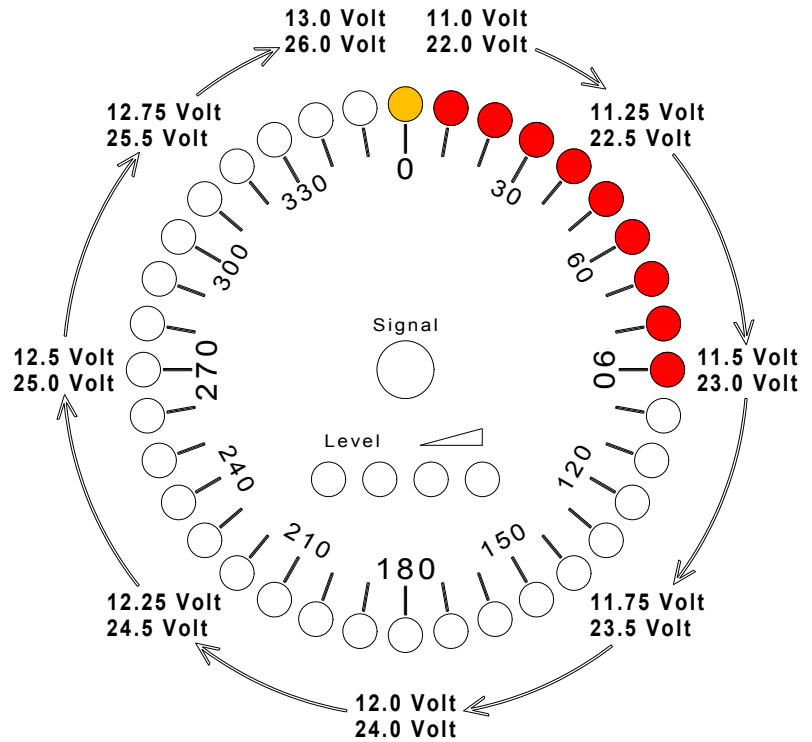

Display of actual battery voltage or power supply

**4.2.6 Function > [Speaker Icon] < (Speaker) switch off / on speaker**

As soon as the direction finder is receiving an (emergency-) signal, the integrated speaker and, if connected, the external speaker and alarm bell will be activated, to call the crew's attention to the emergency. You can, if disturbed by the warning sound during rescue operations, switch it off by using the > [Speaker Icon] < - ON/OFF-push-button.

The activated >Speaker Off< - LED in the display indicates the switched off speaker. As soon as the reception of the emergency signal is interrupted for more than 60 seconds the speaker and the alarm exit are reactivated automatically and the >Speaker Off< - LED becomes extinct - e.g. after saving a crew member and having switched off the transmitter. This guarantees, that the function >switch off speaker< is not forgotten by mistake and the next emergency is recognised.

**4.2.7 Function > IDENT < (Distress-Signal identification)**

By pressing the >IDENT<-button the Distress-Signal-Identification is switched ON/OFF. If the Distress-Signal-Identification is switched OFF, then all received signals are activating the

speaker and, if connected, the alarm bell. In this way the very sensitive direction finder receiver can be activated through strong interfering transmitter (above all, near harbours), and causes unwelcome false alarms. Switching ON the Distress-Signal-Identification (the >ELT only< - LED lights) avoids this, and the speaker and a connected alarm bell get now only activated if a Distress-Signal is received and identified. The identification is based on the typical Distress-Signal-down/up-ward audio-frequency sweep (see chapter 2.1 >Electrical characteristics<).

#### 4.2.8 Function > FREQ. <

By pressing the >FREQ.< button the two possible receiver frequencies are switched. The normal frequency is the emergency frequency. The other second frequency is a test frequency. The red LED >Test-Freq.< indicates this test frequency (see chapter 2.1 >Electrical characteristics<).

#### **WARNING:**

The test-frequency is only for use with a transmitter sending at the test-frequency. In this mode NO Distress-Signal-Transmitters (frequency 121.500 MHz) can be received!

#### 4.2.9 Function > SQUELCH - <

Pressing the >SQUELCH - < button will first indicate the actual squelch level, when keeping pressed for more than 2 seconds the squelch level will decrease.

Decreasing the squelch level makes the receiver *more* sensitive for weak signals, but as well as for other interfering signals and noise.

#### 4.2.10 Function > SQUELCH + <

Pressing the >SQUELCH + < button will first indicate the actual squelch level, when keeping pressed for more than 2 seconds the squelch level will increase.

Increasing the squelch level makes the receiver *less* sensitive for weak signals, noise and other interfering signals will be suppressed.

#### **ATTENTION:**

In order to adjust the squelch level properly and to obtain best bearing results, decrease the squelch level until the noise becomes audible. Then increase the squelch level *just until* the noise becomes suppressed. Now the receiver is most sensitive for the bearing signal and less disturbed by other noises. During bearing this adjustment may have to be executed several times.

## 4.3 Additional functions

### 4.3.1 Adjusting of a display-offset

If a constant bearing error should appear after having adjusted the antenna, the direction finder can be calibrated subsequently by using the display-offset function.

This function is purposely a bit awkward to exclude maladjustment by mistake.

#### Procedure:

- The device has to be switched off.
- Then the device has to be switched on.
- During the >switch on< reaction (all 36 LED's light clockwise) the push-buttons >**CLEAR**< and >▶< have to be pressed at the same time until the adjusted offset value is displayed flashing quickly. Now you are in the proper mode to adjust the offset value. (The axis system lights weakly).
- Release pushbuttons.
- Each pressing of the push-button >**CLEAR**< changes the displayed offset value for **+5°**, step by step.
- Each pressing of the push-button >▶< changes the displayed offset value for **-5°**, step by step.
- In order to store the adjusted offset value, you have to press the push-button >**IDENT**< to confirm. Then the display is extinct for a short moment. After that the new offset value is displayed once again (1 sec), and the normal mode of operation is existing again.

**Remark:** When staying in the offset mode and if there is no button pressed for more than 10 sec, the offset mode will be left **without** any change. The adjusted offset is displayed every time when switching on (see chapter 4.1.1 Switch-on reaction).

## 4.4 Testing of nominal qualities

After installing the direction finder for the first time, the nominal qualities have to be checked at least once a year. If installed on watercrafts or land vehicles the test procedure should be executed before each major excursion. If testing the nominal qualities and if the direction finder is operated on the emergency frequency (121.500 MHz) take extreme care not to cause alarm by mistake. It became naturalised for testing purposes to switch on the emergency transmitter before and after every whole hour for max. 5 min. Watch local regulations!

#### 4.4.1 Testing of nominal qualities on watercrafts or land vehicles

The watercraft respectively the land vehicle has to be on a plain surface. Because of reflections a reasonable judgement of the bearing accuracy is not possible within a harbour or a built on area. The bearing signal can be reflected by any conducting surface and subjects and might not reach the bearing antenna in straight direction. So the real signal will be superimposed by reflections thus effecting bearing errors up to 180°!!

Switch on the transmitter. The distance between transmitter and bearing antenna should be at least 50 m. Start the test exactly in extension of the longitudinal axis of the craft.

The bearing display should light now the 0°-LED. Now move slowly, in a circle, the transmitter around the antenna (caution: drag error). (Very suitable on water: rubber dinghy.)

The bearing display should track the transmitter continuously. The correct bearing display in direction of the longitudinal axis is of importance.

If a constant deviation (in size and direction) is detected, it can be corrected by adjusting the antenna or the offset value (see chapter 4.3.1 Adjusting of a display-offset).

Especially on yachts, where the antenna is not mounted on top of the mast, bearing errors are to be expected. Rigging may cause reflections, which cannot be corrected. Size and direction are changing depending on antenna position an angle of incoming signals. If that is the case, the optimum antenna position has to be found out by trying.

#### Remark:

Even if there are considerable bearing errors (up to 45°) the watercraft will reach the lost person, just by heading the indicated direction. (See drawing)

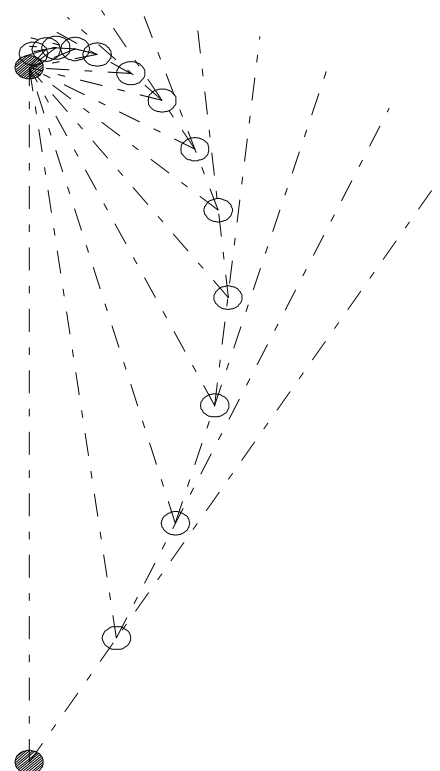

*Approach to the transmitter despite 30° bearing error*

#### **4.4.2 Testing of nominal qualities, stationary use.**

After installation and adjusting the antenna of the bearing device, distinct positions around the antenna are to be chosen (distance: 100m to 1000m), which can be found even after long time. Switch on the transmitter on these positions and note the indicated bearing value. These bearings can be repeated at any time and compared with the noted values.

## **5 Available Accessories**

- ALU- Display-housing
- 6-hole-mast-flange
- cable strain relief clamp
- Mast tube
- Mast tube reducer
- Mast tube connector
- connector
- Antenna cable
- Power/Remote-Cable including fuseholder
- Linking cable Direction Finder ↔ PC
- Data transfer modem
- Display software „Bearing display“



## 6 Declaration of Conformity



RHOTHETA Elektronik GmbH  
Dr.-Ingeborg-Haackel-Str. 2  
82418 Murnau  
Germany

Tel.: +49 8841 4879 - 0 E-Mail: email@rhoteta.de  
Fax: +49 8841 4879 - 15 Internet: www.rhoteta.de

**EU Declaration of Conformity**  
**EU-Konformitätserklärung**  
**RT-200 / RT-202**  
**[Rev 2.01]**

### EU Declaration of Conformity EU-Konformitätserklärung

**Type of Product:** RT-200 / RT-202 Crew Finder (also known as MDF 200 / MDF 202)  
**Gerätetyp:** RT-200 / RT-202 Crew Finder (auch bekannt als MDF 200 / MDF 202)

**Components of Product**  
**Komponenten des Produktes** : RT-200 / RT-202 Antenna Unit (AU),  
RT-200 / RT-202 Display Control Unit (DCU)

**Product Designation:** MOB Direction Finder  
**Bestimmungsgemäße Verwendung:** MOB-Peilgerät

We, RHOTHETA Elektronik GmbH, Dr.-Ingeborg-Haackel-Str. 2, 82418 Murnau, Germany, declare under our sole responsibility that the product, and product family, identified above is in conformity with the essential requirements and other relevant requirements of:

- Directive 1999/5/EC on radio equipment and telecommunications terminal equipment (relevant for RT-200 / RT-202 AU)
- Directive 2004/108/EC relating to electromagnetic compatibility (relevant for RT-200 / RT-202 DCU)
- Directive 2006/95/EC relating to electrical equipment designed for use within certain voltage limits (relevant for RT-200 / RT-202 DCU)
- Directive 2011/65/EU on the restriction of the use of certain hazardous substances in electrical and electronic equipment (relevant for RT-200 / RT-202 AU and RT-200 / RT-202 DCU)

Wir, die RHOTHETA Elektronik GmbH, Dr.-Ingeborg-Haackel-Str. 2, 82418 Murnau, Deutschland, erklären hiemit in alleiniger Verantwortung, dass das oben genannte Produkt und die Produktfamilie den grundlegenden Anforderungen und den übrigen relevanten Anforderungen entspricht:

- der Richtlinie 1999/5/EG über Funkanlagen und Telekommunikationsendeinrichtungen (relevant für RT-200 / RT-202 AU)
- der Richtlinie 2004/108/EG über die elektromagnetische Verträglichkeit (relevant für RT-200 / RT-202 DCU)
- der Richtlinie 2006/95/EG betreffend elektrische Betriebsmittel zur Verwendung innerhalb bestimmter Spannungsgrenzen (relevant für RT-200 / RT-202 DCU)
- der Richtlinie 2011/65/EU zur Beschränkung der Verwendung bestimmter gefährlicher Stoffe in Elektro- und Elektronikgeräten (relevant für RT-200 / RT-202 AU und RT-200 / RT-202 DCU)

**For the RT-200 / RT-202 AU the following harmonised standards are applied:**  
**Für die RT-200 / RT-202 AU wurden die nachfolgenden harmonisierten Normen angewandt:**

HEALTH & SAFETY (Art. 3 (1)(a)): EN 60950-1:2006 / AC:2011  
Gesundheit und Sicherheit (Art. 3 (1)(a)): EN 60950-22:2006 / AC:2008  
EMC (Art. 3(1)(b)): EN 60945:2002  
Elektromagnetische Verträglichkeit (Art. 3(1)(b)):

**For the RT-200 / RT-202 DCU the following harmonised standards are applied:**  
**Für die RT-200 / RT-202 DCU wurden die nachfolgenden harmonisierten Normen angewandt:**

HEALTH & SAFETY (Art. 3 (1)(a)): EN 60950-1:2006 / AC:2011  
Gesundheit und Sicherheit (Art. 3 (1)(a)): EN 60945:2002  
EMC (Art. 3(1)(b)): EN 60945:2002  
Elektromagnetische Verträglichkeit (Art. 3(1)(b)):

Murnau, 2014-06-12  
Murnau, den 12.06.2014

  
.....  
Wolfgang Pichl  
(Managing Director)  
(Geschäftsführer)

## 7 Appendix

### 7.1 Test protocol

(enclosed)

### 7.2 Drawing for mounting of the Display Control Unit

(enclosed as stencil drawing)

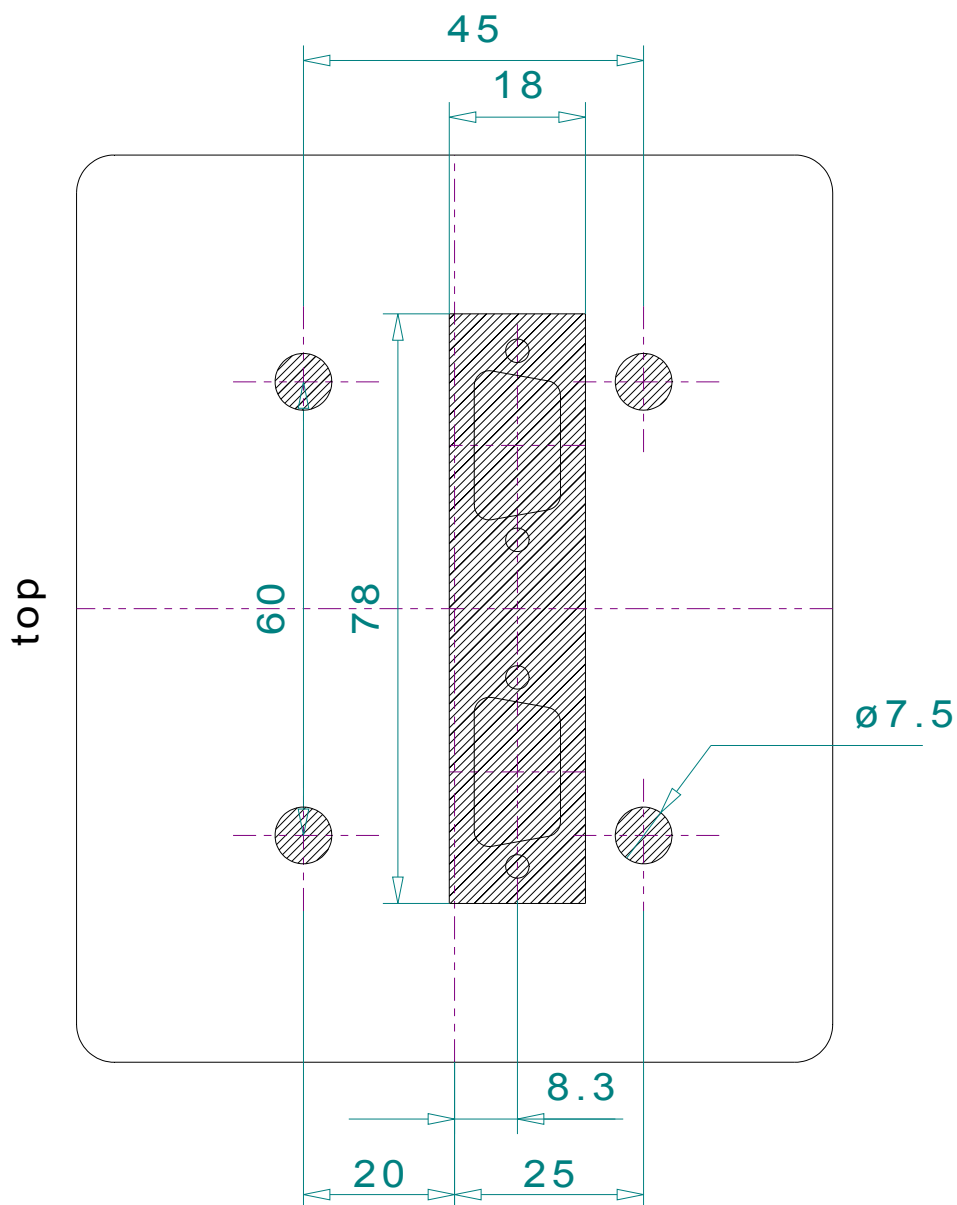

*Stencil drawing for mounting of the display unit*